

# **SEPADU**<sup>™</sup> **SPECIALTY**

Specialist Consultancy Services for -  
Non-Metallic-Piping, Ducting,  
Equipment, Stack & Liners.



SEPADU Specialty Engineering Services Pvt Ltd. is One Stop Engineering Services provider to Oil & Gas, Power, Water & Waste water treatment, New energy & Carbon Capture, Chemical & allied Industries across the globe for Complete project Life cycle .

## VISION

To be World Class Engineering Solution Provider.

## MISSION

SEPADU Specialty aims to achieve business success & Sustain by Providing Cost - Effective Value Engineering & Solutions by complying to Stringent Health, safety, Environment (HSE)

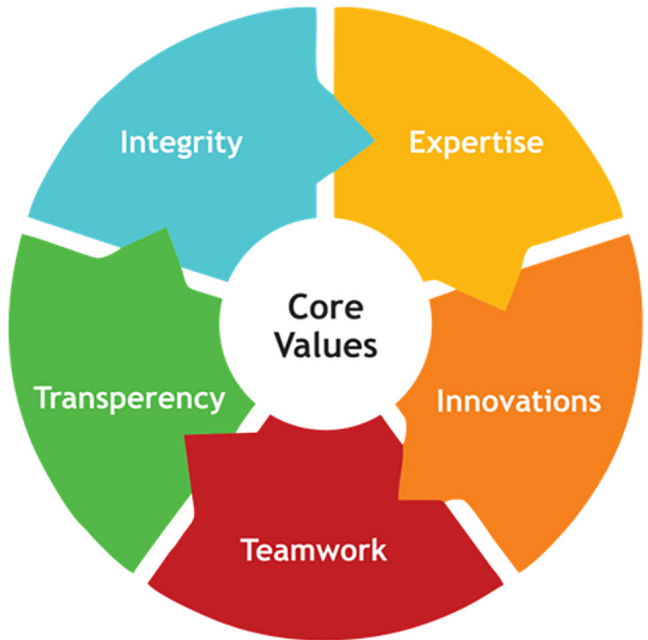

FRP/GRE/GRV/RTR Piping & Ducting System.

Thermoplastic Piping System ( PVC, CPVC, ABS, PE, PP, FEP)

FGD-FRP Piping & Spray Header.

Dual Laminate ( TP+ FRP) Piping System.

FRP Equipment- Tank , Vessel, Columns,Stacks

FRP Structure , Cable Tray & Ladders, Gratings

TP & FRP Liners- Tanks, Equipemnt , Piping, Chimney

RTP Piping & Pipelines Systems





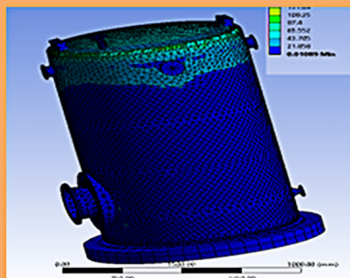

**FEA & CFD  
Analysis**

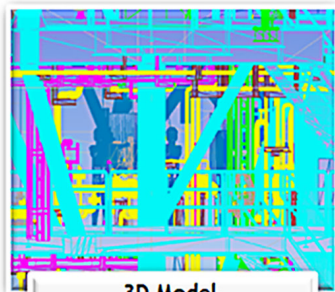

**3D Model-  
SP3D/PDMS/E3D/AUTOCAD  
PLANT3D**

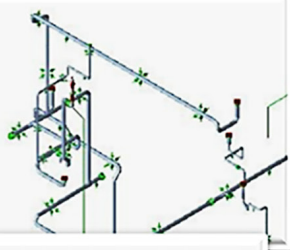

**Stress Analysis**

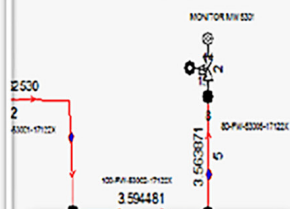

**Surge Analysis**

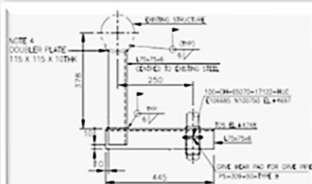

**PSA-HLIC-0008A  
Pipe Support  
Detail**



**Isometric  
Drawing**



Product Qualification-Short term Burst Test /Long Term (1000 Hr) Testing



Fire Endurance Testing (IMO Level 3)



Electrostatic Conduance Check -ISO 14692



Electrostatic Conduance Check -ISO 14692



Earthing System

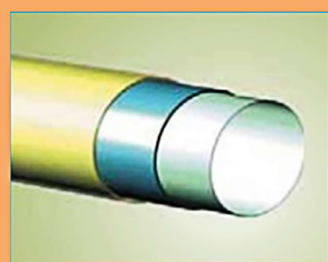

UV Protection Layer



Bonder Qualifications-Butt & Wrap



Testing

**PROJECT TRACK:** New Energy & Carbon Capture  
Green Hydrogen, Green Ammonia, Green Methanol, Carbon Capture Projects



GRE, GRVE, PP Lined GRV, FEP Lined GRV, Piping System.

- DM Water System
- Fire Water System
- KOH Supply & Return System
- CO2 & Hydrogen , Ammonia & Methanol



**PROJECT TRACK : New Energy & Carbon Capture**  
**Green Hydrogen, Green Ammonia, Green Methanol, Carbon Capture**

Project Name	Owner / Operator	Order by	Scope
NEOM GHE Project (GHE) (650 T/ day)	Air Product	ThyssenKrupp	Manpower for Engineering activites (Layout,Piping & SP3D Modeling Scope ) for Electrolyser scope.
NEOM HIDC Project	Air Product	CPP India	SP-3D Catalogues,Stress analysis, 3D Model review,IFC Isometrics with BOM, Pipe support design & detail, MTO for interconnecting DM water KOH System (FEP lined GRV piping)
NEOM GHE Project (650 T/ day)	Air Product	CPP India	SP-3D catalogues, Stress analysis including Module transportation case analysis,3d Model review IFC Isometrics with BOM, pipe support design & detail,MTO for KOH system (FEP lined GRV Piping), FEA study to check shear build up & relative thermal expansion of FEP / PP Liner, support Strength check.
NEOM GHE Project (650 T/ day)	Air Product	CPP India	SP-3D catalouge, Stress analysis, 3D Model review, IFC Isometrics with BOM Pipe support design & detail, MTO for DM Water system (PP-R lined GRV piping )
Casa Garande Green Hydrogen Project	Air Product	CPP India	Stress analysis, 3D Model review, IFC Isometrics with BOM, Pipe support design & details.MTO for DM Water system (PP-R lined GRV piping)





**PROJECT TRACK RECORD: Oil & Gas  
(Terminals, Refinery & Petrochemicals)**



**GRE / GRVE / HDPE / RTP Piping and Equipments.**

- Hydrocarbon Gases / Liquid
- Fire water system
- Service Water
- Cooling Media
- HAZ/NON - HAZ Drain System
- Drain (Oily Water)
- Sea water Intake
- Effluent treatment plant piping
- Hypochlorite & Dosing chemical
- DM Plant
- Desalination Plant Piping



Project Name	Owner / EPC	Year Dates	Order by - EPC / OEM	Scope of Work	Country
RAPID Package 16B Raw Water Treatment Plant 230MLD(Million Liters per Day)	Petronas / WET	2016	Sepadu Malaysia/ CPP	Detailed Engineering for GRVE ,GRE Piping system, Surge,Stress, IFC ISO, Support & thurst block details	Malaysia
RAPID Package P-14-701 UIO- Fire water system network 60 Km	Petronas / OUI JV / PBJV	2016	Sepadu Malaysia/ CPP	Detailed Engineering services Piping, Civil & Structural, SP -3D Modeling, Surge analysis of fire water system , Stress, IFC ISO , Support & thurst block details, Support, foundation, ditches, Culvert, valve pit, Pipe Rack structural.	Malaysia
RAPID Package P-27 HDPE Package	Petronas / Techni mount	2016	Sepadu Malaysia/ CPP	Detailed Engineering - Piping, Civil & Structural SP- Surge analysis of Fire water system, Stress analysis, IFC ISO, Support & thurst block deatils,Support, foundation, ditches, Culvert, valve pit.	Malaysia
RAPID Package 14-DM, Condensate polishing & Oily-Condensate Coalescer Plant	Petronas / OUI JV / ENVIPIRE SINGAPORE	2016	Sepadu Malaysia/ CPP	Detailed Engineering services for GRVE , GRE Piping system, Surge, stress, IFC ISO, Support design and detail Drawings	Malaysia
Shell Majnoon Field Development Project-- Vacuum Dearetor , SUF, ACF, RO, RO-CIF Packages	SHELL Iraq	2017	Aquatech / CPP	GRE / GRVE Piping System, pipe stress analysis, Piping Isometrics with MTO, Spool ISO, Support design and Detail Drawings.	Iraq
BPCL LPG Terminal Haldia	BPCL / KALPATARU	2017	CPP India	Stress analysis of GRVE & GRE Piping system, Support Details.	India
YIBAL KHUFF	Petroleum Development Oman / PETROFAC	2017	CPP India	Raw water in take & Fire water system, GRE / GRVE System Stress, Pipe support details, AFC & Spool ISO.	Oman
YIBAL KHUFF	Petroleum Development Oman/ GE A Germany	2017	CPP India	Waste water treatment Package, Stress, Pipe support detail, AFC & Spool ISO.	Oman
YIBAL KHUFF	Petroleum Development Oman / Aquatech	2017	CPP India	Raw water treatment Package - GREP Piping Stress analysis & support details	Oman
UZBEK OLTIN YO'L / GTL Project	OLTIN YO'L / Hunyadi E & C	2017	CPP India	GRE/GRVE Piping for water Treatment Package & Sea water IntakeSystem, Pipe stress analysis,Piping Isometrics with MTO, Spool ISO, Support design and Detail Drwaings	Uzbekistan

## PROJECT TRACK : Oil & Gas

Project Name	Owner/EPC	Year Dates	Order by - EPC / OEM	Scope of Work	Country
RAPID P14-SS50 ECN for EURO 5 / SER / FFTG	Petronas - PRPC / OUI JV of FLUR & TECHNIP	2018	Sepadu Tech Malaysia	Engineering services for underground fire water in UIO / FFTG GRE Piping system scope including SP 3D Modeling , Surge analysis, Stress analysis, Support detail ISO, SPOOL ISO, thrust block design, underground culvert, trances, ditches, Reverse Engineering to cater Modefication on pipe bridge, supports.	Malaysia
Mangalore Refinery Pvt .Ltd (30 MLD SWRO)	MRPL / WABAG	2019	CPP India	Detail Engineering for 800 NB GRVE Pipeline, Refinery Pump house & supply Piping Stress Analysis detail design TBs and support	India
Sulphate removal Plant	Crain Vedanta / Ion exchange	2019	CPP India	Produced water Treatment Plant, Firewater, Drain & Vent system PDMS Model updation, Surge Analysis & Pipe Stress analysis, support detail drawing, Piping Isometrics with MTO, Spool drawing	India
AISHWARY, Haldia Refinery	IOCL / Punj Loyeed	2019	CPP India	Conceptual GAD, Isometrics with BOM, Surge & Stress analysis Support detail, Spool ISO	India
Exxon offshore production Facilities	Exxon Mobil Malaysia	2019	Sepadu Malaysia	Comparative study of steel & FRP Profile Platform based FEA analysis. Detail fabrication drawings FRP Platform for offshore Application	Malaysia
ADNOC WHR -ZLD	ADNOC / VIAOLIA ENTROPEE	2019	CPP India	ETP & Zero liquid discharge Plant GRE Piping- Surge & Stress Analysis for GRP Piping, support detail, IFS & Spool ISO	India
LNG Regasification Terminal	Petronas / CMI	2020	Sepadu Tech Malaysia	IFC Isometrics with BOM . Stress Analysis GRE Piping, SP 3D Model, As built Isometric drawing, Thrust block calculation and detail drawing	Malaysia
BINTULU Terminal - (BAGSF-2)	Petronas / Petrofac	2022	Sepadu Tech Malaysia	Ungderground GRVE Firewater system - Stress Analysis, Surge analysis, Support detailing updation of final MTO	Malaysia
Reliance -Jamnager Refinery - JMW MTF	Sikka Ports & Terminals Ltd.	2022	CPP India	GRE Piping system ,Surge analysis, Stress analysis, Support detailing & IFC ISO MTO	India
ECPP of effluent managment (EMAS)	Malaysian Refining Company SDN BHD	2022	HRSB /Sepadu techservices SDN BHD	Detailed Engineering for underground Facilities, GRE & GRVE Non-Metallic piping system for effluent & water supply sytems. Surge analysis Stress analysis. PDMS modeling, Support details, civil underground facilities detailing	Malaysia
Singapore Polyethylene Plant - Brownfiled	Exxon Mobil Chemicals	2022	Exxon Mobil Chemicals	Specification for GRE Piping, Line list ,P& ID , Surge analysis, AUTOCAD PALNT 3D, GAD Civil detail drawing, piping ISO with BOM, MTO. Support detail, Spool ISO, Procurement Support- RFQ/TQ/TBE, As -built docs.	Singapore





- Hydrocarbon oil & Gas
- Produced water
- Fire water system
- Drain system
- Sea water Intake & Water Injection System
- Cassions
- Dosing Chemicals
- Potable Water

**ExxonMobil**

**CALM  
OCEANS  
MCP**

**PETRONAS**

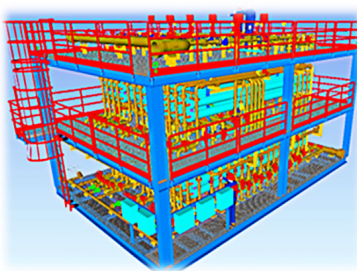
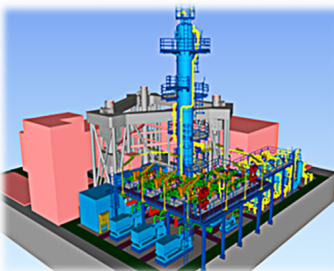

## PROJECT TRACK : Offshore Project

Project Name	Owner/ Operator	Order by	Scope
Bokor Well Head Platform (BODP - D/F/E Platform)	Petrons / Brook Shipyard	Sepadu Tech Malaysia/CPP	P & ID, Surge analysis for fire water piping, 3D Modeling using PDMS, Support using MDS, IFC Isometric with BOM, Spool Dwg, MTO, Support detail
Bokor CPP - Produced Water treatment , Sea water treatment & injection, Chemical dosing modules	Petrons / Brook Shipyard	KYS Energy Singapore / Sepadu Tech Malaysia	P & ID, Line list, Surge analysis, Piping Engineering PDMS Modeling, Pipe stress analysis, Pipe support modeling using MDS, Piping Isometrics with MTO, Spool drawing, Support detail drawing
Sammarang EOR	Petrons / Petra Resources	Prosys- Malaysia	Brownfield Modification & addition of new polymer & water injection package, Scope include GRE/ GRVE System, PDMS Modeling, IFC ISO, Stress analysis, Support detail, Blast case for stress.
OKWOK-FPSO Topside Production Facilities	Technomax Process System FZC	Chemical Process Piping Pvt Ltd	Detailed Engineering for Sea water Injection Module Piping Stress analysis of GRE Sea water system Load Case- Thermal Operating Operating + Wind, Blast, Transportation case, Equipment & Structural Displacement due to Ship motion
Water Taxi Project	Technomax Process System FZC	Chemical Process Piping Pvt Ltd	Detailed Engineering for Sea water Injection Module Piping Engineering, Piping Stress analysis of Sea water system





### GRE/ GRVE /HDPE Piping and Equipment

- Sea water intake
- Fire water system
- DM & Condensate Polishing Unit Piping
- Produced Water
- UF / Micro filtration Piping
- Clarifer water tank - Inlet & Outlet Piping
- Backwash Filter - Inlet & Outlet Piping
- RO flushing Tank Piping
- Neutralization Tank Piping
- Coagulation Tank Piping
- Effluent Transfer Piping
- Product water Piping
- Cooling Media
- Water Pipelines
- Zero Liquid Discharge Plant



# PROJECT TRACK : Water & Desalination

Project	Owner/EPC	Order by-EPC/OEM	Scope of Work	Country
RAPID Package 16B Raw Water Treatment Plant 230MLD	Petronas /WET	Sepadu Malaysia	Detailed Engineering for GRVE, GRE Piping system, Surge,Stress, IFC ISO, Support & thurst block details for Water Treatment Plant	Malaysia
RAPID Package P-14-DM,Condensate polishing	Petronas / OUI JV / ENVIPURE SINGAPORE	Sepadu Malaysia	Detailed Engineering for GRVE, GRE Piping system, Surge,Stress, IFC ISO, Support & thurst block details for Fire Water System	Malaysia
BPCL LPG Terminal Haldia	BPCL / KALPATARU	CPP India	Stress analysis of GRVE & GRE Piping system, support detail for Fire Water System	INDIA
YIBAL KHUFF	PDO Oman/ PETROFAC	CPP India	RAW Water intake & Fire water system, GRE / GRVE Systemn Stress, Pipe support detail, AFC & Spool ISO.	OMAN
YIBAL KHUFF	PDO Oman/ PETROFAC	CPP India	Wast water treatment Package, Stress, Piping, Support detail, AFC & Spool ISO	OMAN
YIBAL KHUFF	PDO Oman/ PETROFAC	CPP India	Raw water treatment package - GRE Piping stress analysis & suport details	OMAN
Bokor CPP - Produced water , Sea water Treatment Chemical dosing Modules	Petronas / Brook shipyard	KYS Energy Singapore / Sepadu Malaysia	P & ID, Line list, Surge Analysis, Piping Engineering - PDMS Model, Pipe Stress analysis , Pipe support Modeling using MDS, Piping Isometric with MTO Spool Drawing, Support detail drawings	offshore-Malaysia
Manglore Refinery Pvt. Ltd -Thannirbhavi-30 MLD SWRO	MRPL / WABAG	CPP India	Detail Engineering for 800 NB GRE Pipeline of 13 km,Pipeline,stress analysis, detail design for TBs and suport, additional scope Refinery, Pump house & supply Pipings.	India
Sulphate removal Plant	Crain Vedanta / Ion exchange	CPP India	Produced water Treatment Plant, Firewater, Drain & Vent System -PDMS Model ' Surge Analysis & Pipe Stress analysis suport Detail drawing, Pipings Isometric with MTO, Spool dwg	India
AISHWARY , Haldia Refinery	IOCL / Punj Loyeed	CPP India	Conceptual GAD, Isometric with BOM, Surge & Stress analysis Suport detail. Spool ISO for Fire water system	India
ADNOC WHR - ZLD	ADNOC / VIAOLIA ENTROPEE	CPP India	Effluent plant & Zero liquid discharge Plant Piping - Surge & Stress Analysis for GRP Piping, Support Details, IFC & Spool ISO	India

# PROJECT TRACK : Water & Desalination

Project	Owner/EPC	Order by- EPC/OEM	Scope of Work	Country
EPCC of effluent managemnet ( EMAS )	Malaysian Refining Company SDN BHD	HRSB / Sepadu Tech Services SDN BHD	Detail Engineering for underground Facilities & Nonmetallic Piping System for effluent & water Supply System. Surge analysis, Stress analysis, PDMS modeling. Support detail, Civil underground facilities detailing.	Malaysia
150 MLD Sea Water Revers osmosis Desalination plant	Chennai metropolitan water Supply & Sewerage Board	CPP India	UG Piping Layouts, Stress analysis	India
OKWOK- FPSO Topside Production Facilities	Technomax process System FZC	CPP India	Stress analysis of GRVE / GRE Piping system, Support Details	Nigeria
Zero effluent discharge	TATA Steel Meramandali/ Aquatech	CPP India	Stress analysis of GRVE / GRE Piping system, Support Details	India
100 ML D ( 50+50 MLD ) Desalination plant Tunisia-Zarat	SONEDE	GCER TUNISIA/ VA Tech Wabag	Sea water Intake & Supply Pipeline, Desalination plant piping -Isometrics with BOM, Surge Analysis, Pipe Stress analysis, Pipe support detail drawing , AFC Piping Isometric with MTOSpool Drawing.	Tunisia
Water Waste Treatment System - K Project	GEC- Ultra Power Water	Organo	Water treatment plant for Electronicx Industry -PP Piping, Pipingrouting, 3D Model : Tanks ( inc NZO ), dosing pump Skid . GA Drawings, Isometric Drawings, Support Drawings	Viet Nam
33 MLD Desalination Plant (Phase-1 22 MLD) at Mundra, (Katch)	TATA Steel	CPP India	Pipe Stress analysis, Support details	India







## GRE/ GRVE /HDPE, PP Lined GRV,FEP lined GRV Pipings & Equipment

- Fire water system
- Cooling media
- Water & effluent treatment Plant Piping
- DM Plant
- Service Water
- Chemical - Chloro - Alakli, Phosperic acid, Caustic soda,soda ash,viscose fiber, Chlorine, Sulphuric acid
- Sea water Intake & treatment
- Hypochlorite & Dosing chemical
- Sea Water Desalination Plant



# PROJECT TRACK : Chemical Plant

Project Name	Owner/ Operator	Order by	Scope	Country
RSPL Chemical Complex SODA ASH Plant	RSPL / Jacobs	Chemical process Piping Pvt Ltd (CPP)	Detail Engineering - GRE, GRVE, Dual Laminate Piping , Surge analysis of Sea water Intake, Closed loop cooling System, Stress analysis, IFC ISO, Support & thrust block detail. Appx 2000 lines.	INDIA
Nirma - Phosperic acid Plant	Nirma PAP / Jacobs	Chemical Process Piping Pvt Ltd (CPP)	Stress analysis, Primary support selection & detail dwg .including Structural, AFC Isometric with BOM, Spool ISO drawing .	INDIA
800 TDP Caustic soda Plant	GNAL/ Thyssenkrup UHDE	Chemical Process Piping Pvt Ltd (CPP)	Fire water & Cooling water system ,Surge analysis, Pipe Stress analysis TB & Pipe support detail drawing, AFC Piping Isometric with MTO Spool drawing .	INDIA
Grasim - Rehla Project	Grasim / Worley	Chemical Process Piping Pvt Ltd CPP)	Stress analysis of GRE, GRVE , Dual Laminate, CPVC Piping system , Stress analysis, Support detail, IFC /Spool ISO.	INDIA
OCP - DAP Plant -Gas Scrubbing System	JESA	Chemical Process Piping Pvt Ltd / Chemical Process Equipment	Design & analysis of FRP Ducting system. FEA analysis of Circular & Rectangular ducting. Dynamic analysis of Ducting system - Model, Harmonic Analysis, Structural analysis, FEA analysis of venturi , dryer scrubber. Dust / Fume scrubber & PRE Scrubber, GRE Piping Stress analysis.	MOROCCO
GACL -PAP Project	GACL / Worley	Chemical Process Piping Pvt Ltd (CPP)	Pipe Stress analysis of GRE / GRVE Piping (350 line ),support detail drawing TBE for Bellows, Spring IFC ISO, Spool drawing	INDIA
PTA Project	Deepak	Toyo	Pipe Surge analysis of GRE / GRVE Piping (350 line ),support detail drawing TBE for Bellows, Springs . IFC ISO, Spool drawing	INDIA



## TRACK RECORD: Power Plant & FGD



### GRE / GRVE / HDPE Piping Equipment

- Sea water Intake & treatment
- Dosing Chemical
- DM / Condensate polishing Plant Piping
- Lime Slurry Piping
- Service Water
- Feed & Make up Water Piping
- Cooling media
- Water treatment piping
- FGD Spary header Piping



Project	Owner	EPC	Licensor	Scope of Work
FGD -Super Thermal Power Project Stage - I ( 2 * 800 MW)-GADARWARA	NTPC LTD	ISGEC Heavy Engg LTD.	BABCOCK POWER ENVIRONMENTAL INC.	Detailed Engineering, Piping Surge, Stress analysis of CS + RL , FRP Piping
FGD -Super Thermal Power Project Stage - I ( 3 * 800 MW)-KUDGI	NTPC LTD	ISGEC Heavy Engg LTD.	BABCOCK POWER ENVIRONMENTAL INC.	Detailed Engineering, Piping Surge, Stress analysis of CS + RL , FRP Piping
FGD -Super Thermal Power Project Stage - I ( 260 MW)-KHARGONE	NTPC LTD	L & T Power	-	Detailed Engineering, Piping Stress analysis of FRP Piping
FGD -Super Thermal Power Project Stage - I ( 2 * 700 MW)-	NTPC LTD	L & T Power	-	Detailed Engineering, Piping Stress analysis of FRP Piping
Mundra Thermal Power Plant ( 830 * 5 MW )	TATA - Costal Gujrat Power	TATA Project	ANTRIZ GROUP	Detailed Engineering, Piping Stress analysis of FRP Piping
FGD Feroze Gandhi, TPS Unchahar ( 5 * 210 MW )	NTPC LTD	GE POWER	GE	Detailed Engineering, Piping Stress analysis of FRP Piping
FGD -Meja Thermal Power Project Phase Stage (2 * 660MW)	NTPC LTD	GE POWER	GE	Detailed Engineering, Piping Stress analysis of FRP Piping
FGD JHAJJAR TPS - Stag I (2*550 MW)	NTPC LTD	GE POWER	GE	Detailed Engineering, Piping Stress analysis of FRP Piping
SWG D FOR VANPHONG PHASE I Thermal Power Plant ( 2*660MW)	Van Phong Power Company Limited (VPCL)	MHPS	MHI	Detailed Engineering, Surge, Piping Stress analysis IFC ISO. Piping Support
FGD Thermal Power Station Bokoro ( 500MW)	DVC	Techno Electric & Engineering	KC Cottrel	Detailed Engineering, Surge, Piping Stress analysis IFC ISO. Piping Support



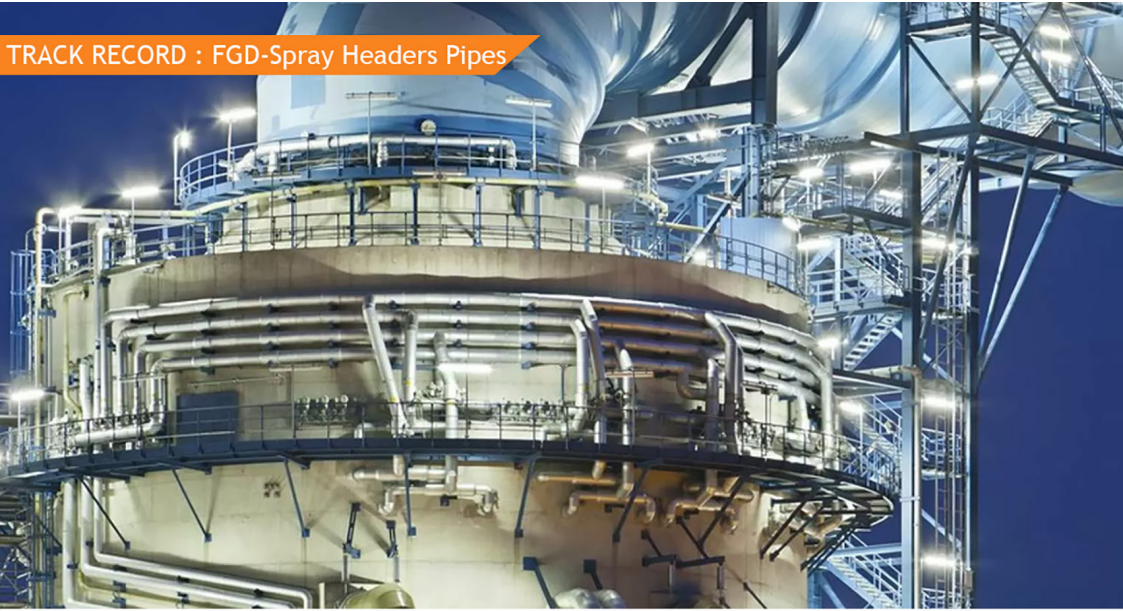

GRP- Piping System - Spray nozzle & Header System

- FEA Analysis -Piping system
- Pipe support design
- Structural detail drawing
- Structural Fabrication Drawings.
- Cooling media
- PDMS Models \* STP formate

FGD - Solapur system Thermal Power Project ( 2\*660mw)  
 FGD - Meja Thermal Power Project Phase Stage (2\*660MW)  
 FGD - Tanda Thermal Power Station 2 (2\*660MW)  
 FGD JHAJJAR TPS -Stage 1 (2\*550MW)



FGD for Singrauli Super Thermal Power Stage I & II -17 M Dia  
 FGD for Singrauli Super Thermal Power Stage I & II -20M Dia  
 FGD for Singrauli Super Thermal Power Stage I & II -17.5M Dia  
 FGD for ANPARA D Thermal Power Plant



FGD - Jhawarpur Super thermal power station (660\*2MW)  
 FGD -Nagison II Thermal Power Plant



FGD for bokaro A Thermal Power Station

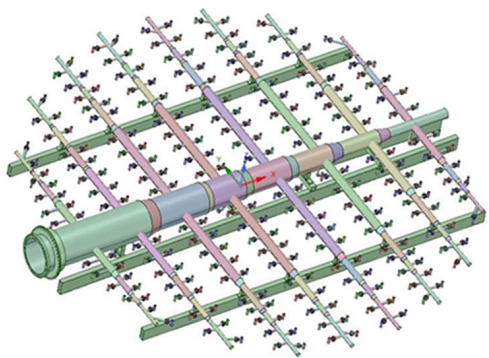

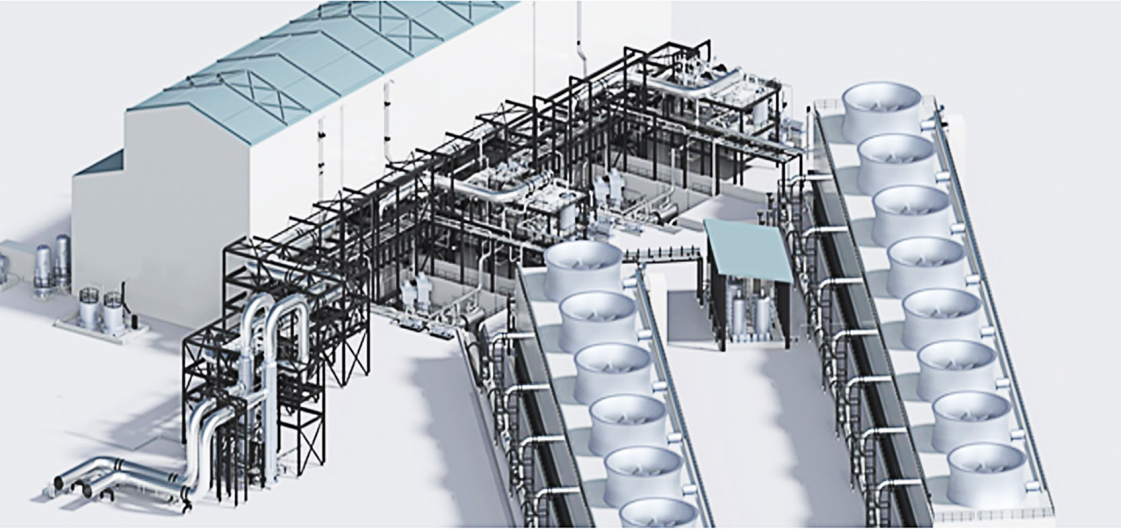

**PROJECT:** 140MW Olkaria V Geothermal Project .  
**OWNER:** Kengen  
**EPC-** Mitsubishi Hitachi Power System (MHPS)  
**GRP-CPP** India

GRP Cooling Water System ( CW Piping Unite -I & II )

PDMS Modeling

Surge analysis

Pipe Stress analysis

Pipe Support Detail drawings

AFC Piping Isometric with MTO

Spool Drawings





**PROJECT- FRP Ducting, Scrubbers & Piping for OCP DAP Plant Morocco**  
**EPC- JESA Morocelo**

**Mechanical**

■ **Scrubbers**

- Pre - Scrubber
- Dryer Scrubber
- Dust & Fume Scrubber
- Design Calculation & Nozzle Strength check using FEA analysis

■ **Structural Engineering**

- GAD
- Structural Design & analysis STADPRO
- Foundation & Structural Detail drawings

■ **Circular & Rectangular FRP ducting system**

**FEA analysis -**

- Static Structural
- Thermal analysis
- Model & Harmonics analysis to cater for Harmonics loads produced by fan motion / Mechanical vibrations
- Seismic analysis
- Fabrication Detail drawings
- Support design & detail drawing

■ **Phase 2**

**Piping Engineering**

- Pipe stress analysis of GRP Piping connected to Scrubber and ducts (100 lines )
- Pipe stress analysis metallic Piping connected to Scrubber and ducts
- Nozzle Qyalification Using FEA analysis

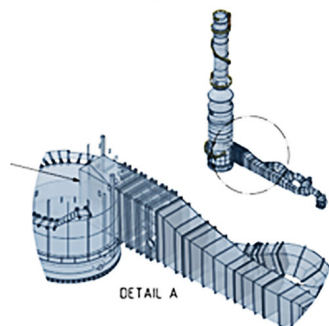

Properties	FRP Platform	Steel Platform
Density	19993 kg/M3	7800 kg/M3
Coeff. of Thermal Exp.	$8 \times 10^{-5} C^{-1}$	$1.2 \times 10^{-5} C^{-1}$
Young's Modulus	19305 MPa	200 GPa
Poisson's Ratio	0.33	0.26
Tensile Yield Strength	206.84MPa	250 MPa
Tensile Ultimate Strength	206.84MPa	400- 550 MPa
Weight	820 kg	2853.4 kg
Corrosion Resistance	High	Low
Installation	Flexible, Easy , No special Tools required	Diffcult , Requires Lifiting Equipment & clamping device due to high weight
Cost	Cheaper Than Steel based on life cycle cost	Costlier Than FRP
Electrical Conductivity	Non - Conductor	Conductor
Thermal Conductivity	Low	High
Maintenance Cost	Low	Costlier Than FRP



## Comparative Study -FRP and Steel Platform

FRP PLATFORM

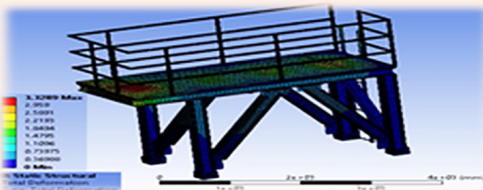

STEEL PLATFORM

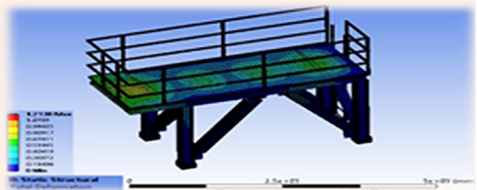

TOTAL DEFORMATION

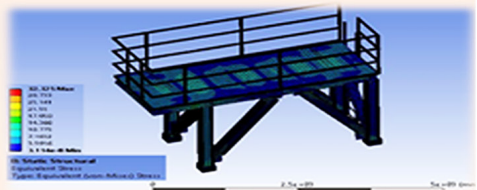
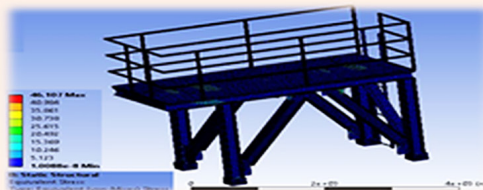

EQUIVALENT STRESS



## Onshore & Offshore Projects

### FEED, Detailed Engineering & Brownfield Engineering Services for

#### Onshore Plants

- Oil & Gas, Refinery & Petrochemical Packages, Chemical, Power, Water & Waste Treatment Projects



#### Offshore Facilities

- Field Development Studies, Wellheads, Central Processing Platforms, FPSO Topside, FLNG

## New Energy & Clean Environment Projects

- Solar Power/Green Hydrogen Plant, Green Ammonia, green Methanol, CO2 Capture, FGD/SCR- SOx NOx Control, Dust, Ash & Fume Handling Systems



## Specialist Consultancy - Product & Systems

- Metallic- Equipment, Boilers, Fired Heaters, Thermal Oxidiser, Reformers, Incinerator, Scrubbers, Bag filters, ESP, SCR, FGD, Ducting, Stack



## Asset Integrity & Brownfield Engineering



Sepadu Tech Academy for professional skill development is established to bridge the gap between academic knowledge and industry requirements. Our courses are job-oriented, professional skill development programs based on the Oil and Gas, Chemical, Power, Marine, Water and Waste water Treatment, New Energy, and Carbon Capture industries. Course completed candidates get the opportunity to work with design consultancy, EPC contractor, Equipment Manufacturer (OEM) and owner operators of above mentioned industry segments .

## List of Courses

- Plant Layout & Piping Engineering
- Process & Process Safety
- Mechanical Static Equipment
- Architectural, Civil & Structural Engineering
- Instrumentation & Control Engineering
- Electrical Engineering

## Advanced Courses

- Offshore Field Development Study & Facilities Layouts
- Offshore Structural Engineering
- Offshore Process & Safety.
- E3D Administration
- SP3d Administration
- Mechanical Product Design (CAD/FEA)

Typical Course duration is 3 months extended up to 6 months to acquire skill sets. Courses includes class room session, Case study Workshops, assignments and real time project exposure.Coaching faculties are from industry. Courses conducted on regular and weekend batches. Regular batches are suggested for fresh graduates and weekend batches for working professionals.





### Manpower

Process Team=8+  
 Regular Employee - 65+  
 Contract staff-10+ In/Out depending need  
 Senior Consultants=12+



### Software & Tools

PIPENET	STADPRO
AUTOCAD 3D	PDMS/E3D
SP-3D	CEASAR-2



Office no. 421, 4th Flooe, Vision One mall, Office Tower Bhumkar Chowk Rd, Wakad, Pune, Maharashtra 411033



